

# FlexStyle™ Ascend

Cordless operated open roll shade

## SUBMITTAL TECHNICAL INFO

### FLSTYLE ASCEND

Please check all appropriate selections and attach room schedule with verified dimensions.

Fabric Series: \_\_\_\_\_

Color Name / Number: \_\_\_\_\_

Openness Factor: \_\_\_\_\_

Please see [Draper® Fabric Options](#) for fabric colors and specifications.

### Specifications

#### EQUIPMENT

**SPRING OPERATOR:** Balanced spring mechanism with metal roller. Adjuster ring built into the spring mechanism allows for finite adjustment of the torque output of the mechanism by turning it clockwise or counterclockwise. A built-in limiter prevents over extension of the spring mechanism.

#### COMPONENTS

**ROLLERS:** Fabricated from extruded aluminum, galvanized steel, or enameled steel. Diameter, wall thickness, and material selected by manufacturer to accommodate shade type and size. Minimum roller diameter 1.5 inches. Dia. X .062" wall (38 mm x 1.6 mm).

#### MOUNTING BRACKETS

**BRACKETS:** Made of .080 die cast aluminum. Can be wall or ceiling mounted. No exposed fasteners.

**FINISHES AVAILABLE:** Black, Bronze Plated, Brushed Gold Plated, Brushed Nickel Plated, Chrome Plated, Grey, Taupe, White, Warm White, Grey Primer.

**ROLLER IDLER ASSEMBLY:** Nylon with spring-loaded pin to interlock with mounting bracket.

#### HEM BAR:

**OPEN POCKET ELLIPTICAL SLAT:** 1 inch (25mm) aluminum elliptical slat with plastic ends inside of a 1 3/8 inch (41mm) pocket.

**FLAT EXPOSED HEM BAR:** Small: 3/8 inch x 3/8 inch (22mm x 8mm) aluminum rectangular hem bar with plastic end caps.

**LARGE EXPOSED HEM BAR:** 1 1/2 inch x 3/8 inch (38mm x 8mm) aluminum rectangular hem bar with plastic end caps.

**ROUND EXPOSED HEM BAR:** Small 3/8 inch (16mm) and Large 1 3/8 inch (21mm) aluminum with plastic end caps.

#### DOWNLOADABLE 3-PART SPECIFICATIONS: [www.draperinc.com](http://www.draperinc.com)

*Please note:* Dimensions of rollers, operators, and hardware at manufacturer's discretion.

#### Available Sizes:

WIDTH:	1'	2'	3'	4'	5'	6'	7'	8'
HEIGHT								
2'								
3'								
4'								
5'								
6'								
7'								
8'								
9'								
10'								

\* Sizes requiring large brackets will vary according to fabric.

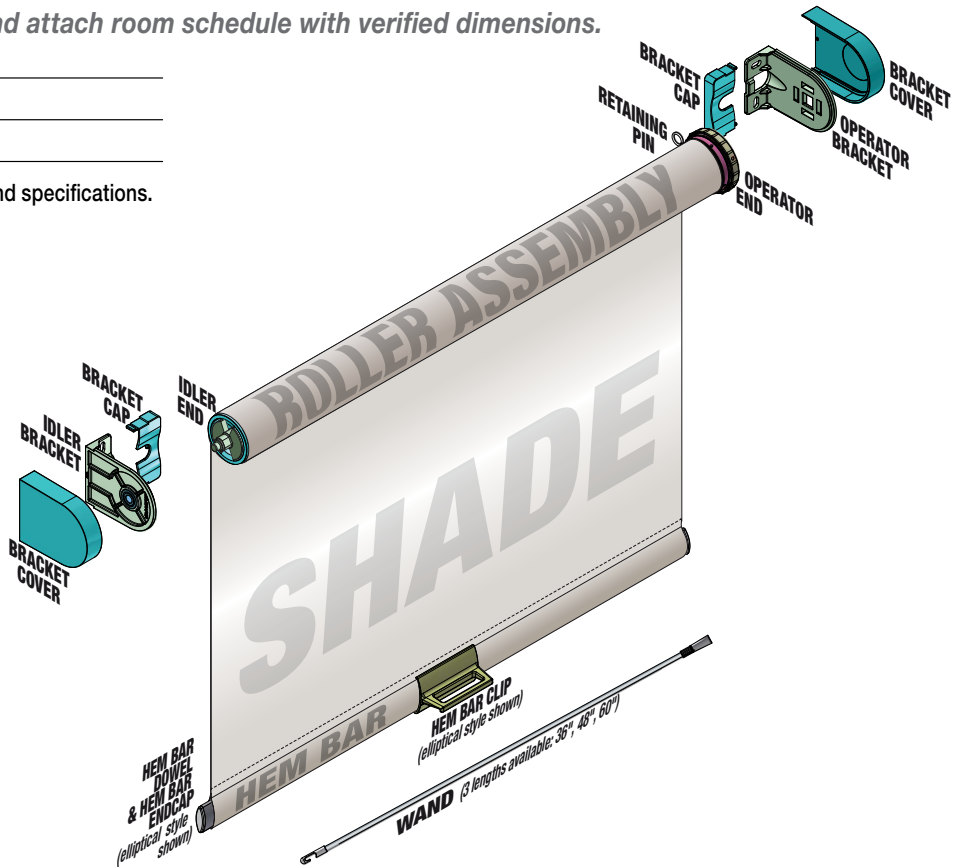

#### Select Hem Bar/Slat Style

- Open Pocket (1" Elliptical)
- Exposed Hem Bar
  - Small Flat Exposed Hem Bar
  - Large Flat Exposed Hem Bar
  - Round Exposed Hem Bar

#### Select Exposed Hem Bar color (For Plated Hardware ONLY)

- SMOOTH COLORS:**
- Matt Black
  - Matt White
  - Matt Grey
  - Matt Taupe
  - Matt Warm White
  - Grey Primer (painted by others)
  - Clear Anodized (not painted)

- TEXTURED COLORS:**
- Black
  - White
  - Ivory
  - Bronze

#### Select Bracket Options

- Select Operator Location (front view)**
- Right (standard)
  - Left (reverse roll ONLY)

#### Plated Bracket Colors

- Brushed Nickel
- Brushed Gold
- Antique Bronze
- Chrome

#### Matt Painted Bracket Colors

- Black
- White
- Grey
- Taupe
- Warm White
- Grey Primer (to be painted by others)

**Please Note:** If Painted Bracket and Exposed Hem Bar are selected, Hem Bar finish is automatically matched to bracket color.

#### Select Optional Accessories

- Pull-Down Wand (available in White only)
  - 36"
  - 48"
  - 60"
- Hem Bar Clip
  - Small Flat Exposed Hem Bar
  - Large Flat Exposed Hem Bar
  - Round Exposed Hem Bar

PROJECT: \_\_\_\_\_

ARCHITECT: \_\_\_\_\_

CONTRACTOR: \_\_\_\_\_

SUPPLIER: \_\_\_\_\_

DATE: \_\_\_\_\_ REVISED: \_\_\_\_\_



Draper, Inc. | 411 S. Pearl St. Spiceland, IN 47385  
[draperinc.com](http://draperinc.com) | 765.987.7999 | 800.238.7999

© 2023 All Rights Reserved | FORM: FlexStyle\_Ascend\_Sub23

## Bracket Dimensions

C002.1822 (Idler End, Extended)

C002.1820 (Motor End, Extended)

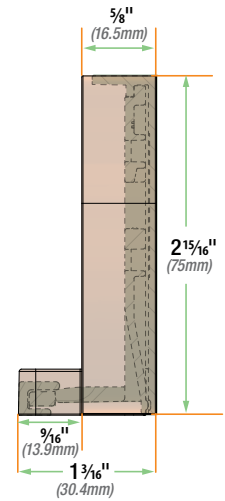
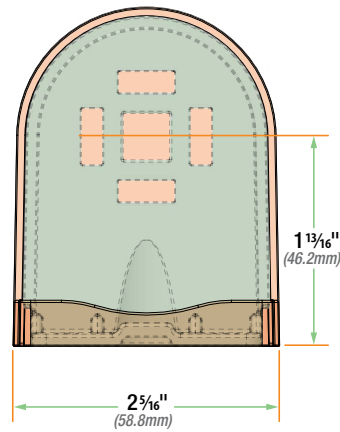
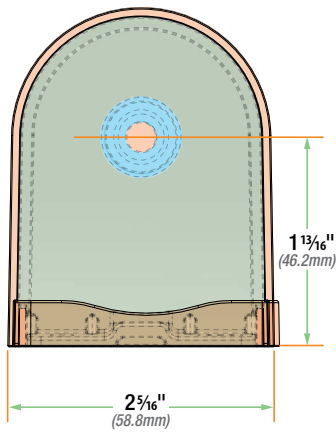
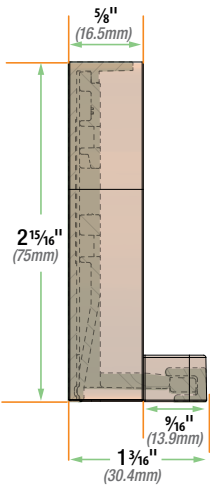
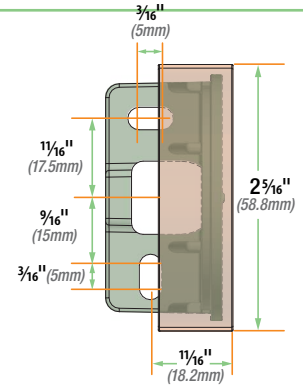
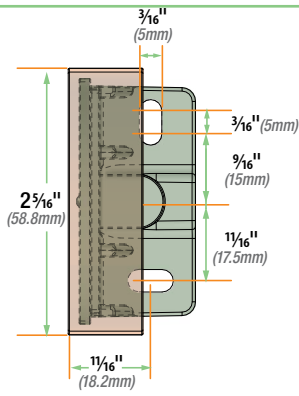

## Shade Dimensions

