

Motorized FlexShade® Zigbee

Standard 4-Wire Motors have no built-in intelligence.



SUBMITTAL TECHNICAL INFO

FLEXSHADE MOZ

Please check all appropriate selections and attach room schedule with verified dimensions.

Select Number of Shades per Unit

- Single Roller (Standard)
- Dual Roller (Supplemental Fabric & Hardware Sheet Required)

Please Note: If you are specifying a Dual Roller FlexShade, please complete the options BELOW and attach the Motorized Dual Roller Fabric and Hardware Planning Sheet.

Select Motor Location

As seen from INSIDE the room facing the window. Also indicate on room schedule.

- Right Side (standard)
- Left Side

Select 120V AC Motor

- Sonesse Motor (standard)
- Sonesse Ultra Motor

Select Control Options

- 120V Wall Switch for Single Shade Control
- Low Voltage and/or Multiple Shade Control

Please see Draper's IntelliFlex Controls Reference Sheet and IntelliFlex® Control System Planning Sheet to design a control solution for this product, available at www.draperinc.com, or by contacting Draper.

Coupled Shades

- Yes (How Many? _____)
- No
- Indicated on attached Dual Roller Sheet

Select Fabric Orientation

- Regular Roll (from back of roller)
- Reverse Roll (from front of roller)

Select Fabric Attachment

- Standard
- Optional Spline Attachment

Select Hem Bar Style

- Closed Pocket - 1" (25 mm) Elliptical (standard)
- Open Pocket - 1" (25 mm) Elliptical
- Flat Exposed Hem Bar
 - Small
 - Large
- Style Bar Hem Bar
 - Exposed (no fabric wrap)
 - Half Wrapped (with shade fabric)
 - Full Wrapped (with shade fabric)
- Round Exposed Hem Bar
- 3/16" (5 mm) Tube
- None

Single Roller Motorized Shade Options

Fabric Series: _____

Color Name / Number: _____

Openness Factor: _____
Please see Draper's Shade Fabric Reference Guide for fabric colors and specifications.

Select Single Roller Hardware

- Wall Brackets
- Ceiling Brackets
- Fascia
- Headbox
 - Ceiling / Wall (Surface Headbox)
 - Type "D" Pocket with Tile Lip (White—not available with 3" roller)
 - Pocket Style
 - Custom Headbox
- Wall Clip
 - With Ceiling Tile Lip
 - Without Ceiling Tile Lip
- Closure Panel for Type "D" Pocket or Wall Clip
 - 1 1/2" 3" 5"
 - (For Wall Clip and Custom Headbox Only)
- "L", "U" or "H" Channels for Light Gap Reduction
 - 'L' Channel
 - 'U' Channel
 - 'H' Channel
 - Channel Liners

Select Hardware Finish (does not apply to Type "D" or Pocket Headbox)

- Clear Anodized (standard)
- Black
- White
- Ivory
- Bronze
- Custom (Contact Draper)

Available Sizes:

| WIDTH: | 2' | 3' | 4' | 5' | 6' | 7' | 8' | 9' | 10' | 11' | 12' | 13' | 14' |
|--------|----|----|----|----|----|----|----|----|-----|-----|-----|-----|-----|
| 2' | | | | | | | | | | | | | |
| 3' | | | | | | | | | | | | | |
| 4' | | | | | | | | | | | | | |
| 5' | | | | | | | | | | | | | |
| 6' | | | | | | | | | | | | | |
| 7' | | | | | | | | | | | | | |
| 8' | | | | | | | | | | | | | |
| 9' | | | | | | | | | | | | | |
| 10' | | | | | | | | | | | | | |
| 11' | | | | | | | | | | | | | |
| 12' | | | | | | | | | | | | | |
| 13' | | | | | | | | | | | | | |
| 14' | | | | | | | | | | | | | |

* Sizes requiring large endcaps/brackets will vary according to fabric.

- Small endcaps/brackets and 2" roller are recommended.
- Large endcaps/brackets and 3" roller may be required.

PROJECT: _____

ARCHITECT: _____

CONTRACTOR: _____

SUPPLIER: _____

DATE: _____ REVISED: _____



Draper, Inc. | 411 S. Pearl St. Spiceland, IN 47385
draperinc.com | 765.987.7999 | 800.238.7999

© 2026 All Rights Reserved | FORM: FS_MOZ_Sub26



Specifications

EQUIPMENT

SONESSE 120V AC ELECTRIC OPERATOR: Drive unit inside roller, 4-wire, instantly reversible, lifetime lubricated. Right hand motor location standard. Left hand available. Adjustable limit switches, thermal overload protector and electric brake. Operates on 110-120V AC 1 HP 60 HZ current. Draws 1.1 Amps. For controls, see IntelliFlex® Controls Reference Sheet and IntelliFlex Controls Planning Sheet.

SONESSE ULTRA 120V AC ELECTRIC OPERATOR: Drive unit inside roller, 4-wire, instantly reversible, lifetime lubricated. Right hand motor location standard. Left hand available. Adjustable limit switches, thermal overload protector and electric brake. Operates on 110-120V AC 1 HP 60 HZ current. Draws 1.1 Amps. Operates at or below sound level of 38 Db. For controls, see IntelliFlex® Controls Reference Sheet and IntelliFlex Controls Planning Sheet. Call Draper for size limitations when using quiet motors.

HARDWARE

ROLLERS: Extruded aluminum or steel. Roller assembly easily removable.

OPTIONAL FABRIC ATTACHMENT: Fabric attached to roller tube with spline fabric attachment method. Allows for removal of fabric panel without removal of roller assembly.

MOUNTING BRACKETS: 1018 plated steel stamping. 2 Sizes: 1 5/8" and 2 1/4". Styles for mounting to wall, ceiling, or jamb. Brackets do not require additional adapters.

ROLLER IDLER ASSEMBLY: Type 6% injected molded nylon and a zinc-plated cold rolled steel pin. Sliding pin for easy installation and removal of the roller.

SLAT: Aluminum, min. 1/8" x 1", encased in heat sealed hem.

ENDCAPS: 1028 steel stamping. 2 sizes: 3 3/4" x 3 3/4" and 4 1/2" x 4 1/2". Complete with adapter roller bracket. Installs to wall, ceiling, or jamb. Accepts fascia or headbox.

ENDCAP COVERS: Plastic covers snap onto endcaps. Available in ivory, bronze, black or white to match fascia.

FASCIA: "L" or radius cover of extruded aluminum, .060 wall. Assembly snaps onto endcaps without exposed fasteners. Clear Anodized (standard), black, white, ivory, or bronze powder coat finish available. Continuous fascia available with coupled units.

HEADBOX: Standard consists of fascia, L-shaped back/top cover. Assembly snaps onto endcaps. Optional, for pocket installation, includes a U-shaped back/top/front cover with removable bottom closure panel. Small size: 3 7/8" x 3 15/16". Large size: 4 11/16" x 4 11/16". Some exposed fasteners required.

TYPE D POCKET: Type D Shade Pocket, to be fabricated of steel for perimeter installation. Accepts FlexShades installed with ceiling brackets. Finished in white paint. 5" x 5 3/8" x .125" with 7/8" tile support lip & removable bottom closure.

"L" ANGLE (3/4" X 1" X 12'3", 1" X 2 3/4" X 16' OR CUT TO LENGTH) **"U" CHANNEL** (1" X 2 1/2" X 16' OR CUT TO LENGTH) **AND "H" CHANNEL** (1" X 5" X 16' OR CUT TO LENGTH): Accepts side edges of fabric, prevents light gaps. Interior of channel provides for use of flat head screws.

COUPLER ASSEMBLY: Zinc plated steel Coupler Shafts shall be retractable into coupler assembly for ease of installation and to lock units in place. Zinc plated steel coupler brackets shall have spherical OD bearings allowing for misalignment of the mounting brackets of up to 1.25-degrees. One motor or crank operator to drive additional shade rollers. Patent pending.

PATENT INFORMATION: Available at www.draperinc.com/legal/patents.

DOWNLOADABLE 3-PART SPECIFICATIONS: www.draperinc.com/documents.aspx.

Please note: Dimensions of rollers, operators, and hardware at manufacturer's discretion.

Hardware Selections

Please Note: Brackets and endcaps have the only attachment points for mounting a motorized FlexShade. Optional fascia and headbox have a thickness of 1/16".

Wall Mounting Bracket

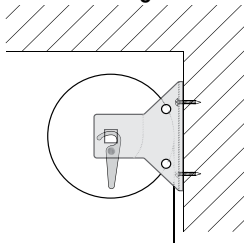

Ceiling Mounting Bracket

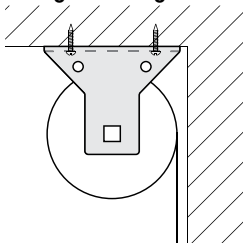

Fascia Only with Ceiling or Wall Mounting Endcaps

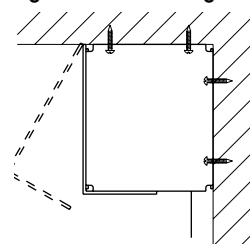

Headbox Installation Options

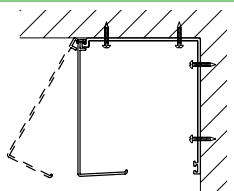

Ceiling / Wall headbox consists of fascia, back/top cover and Ceiling / Wall mounting endcaps

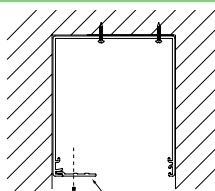

Optional pocket style headbox consists of Draper's extruded pocket with bottom closure panel and ceiling / wall mounting endcaps.

Pocket, Closure & Wall Clip Options

Type D pocket, white in color, features a 5" x 5 3/8" cross-section. A lip along lower edge supports lay-in ceiling. Pre-welded corners and pocket ends are available. Ends come with or without tile support lip (shown).

Type D Pocket

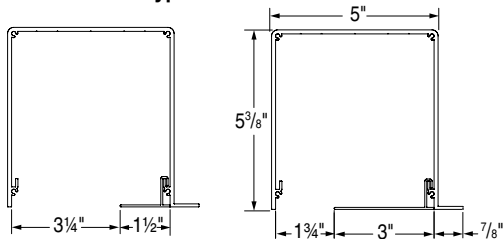

Typical pre-welded corner section (not to scale)

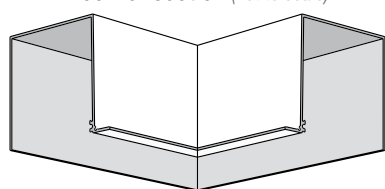

Closure Options

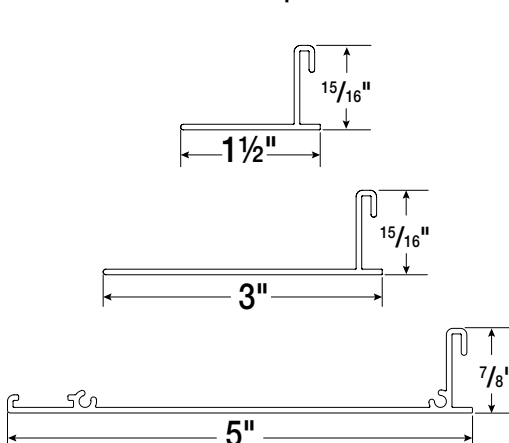

Wall Clip Options

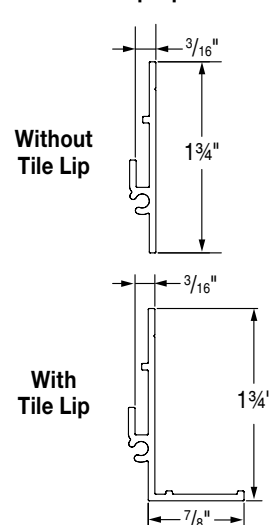

Spline Fabric Attachment

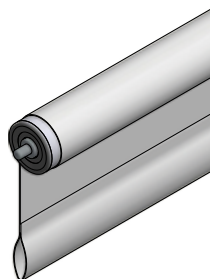

Endcap Covers

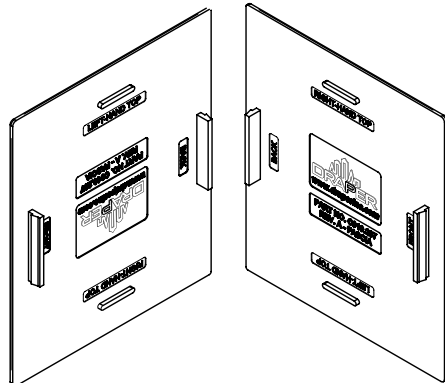

"U" Channel

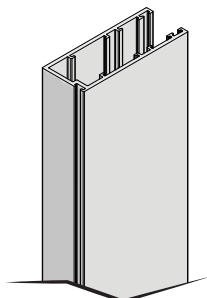

"L" Angle

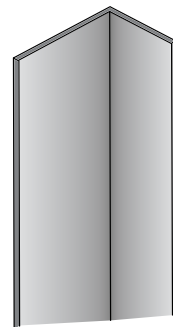

"H" Angle

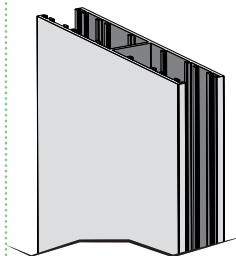

Motorized FlexShade Dimensions

(Fascia Overall Width includes plastic endcap covers) (Pair adds 1/8" to Overall Width)

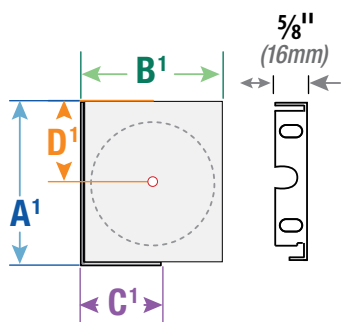
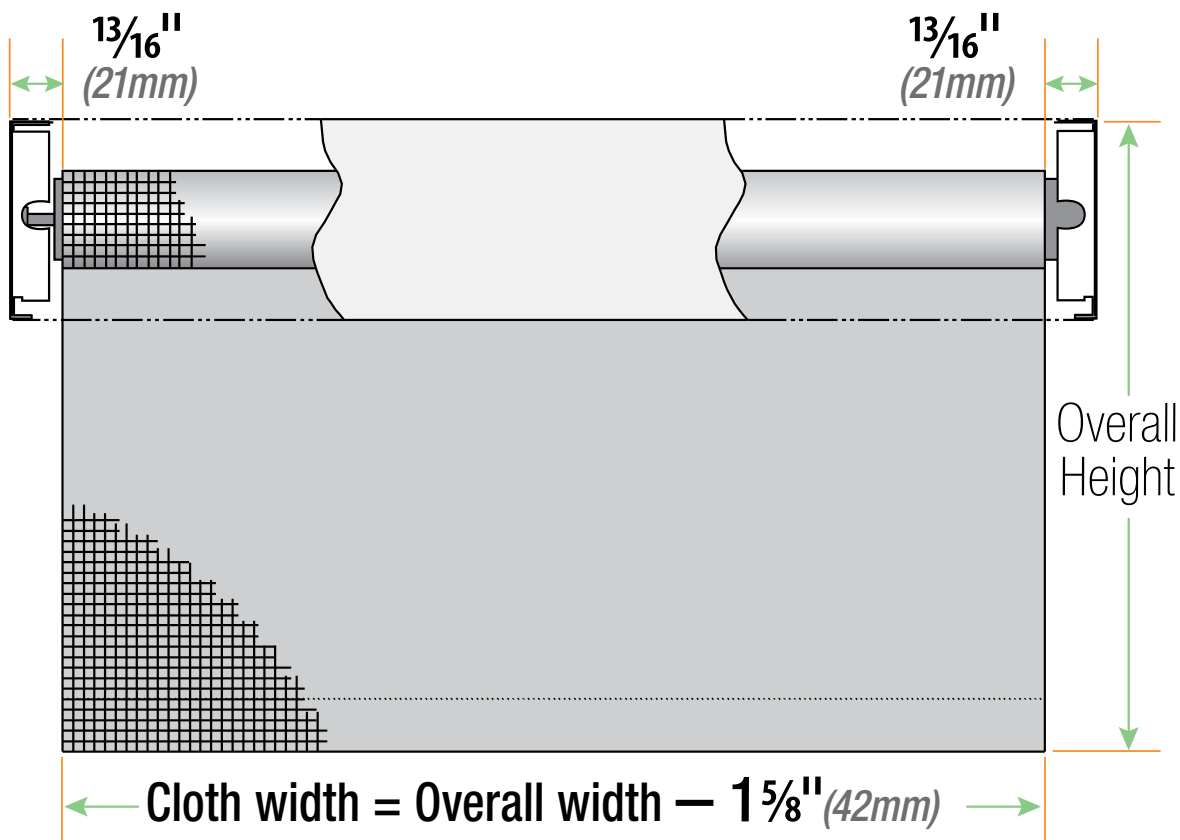

| HEADBOX* | | SMALL | LARGE |
|----------------|---------|-------|---------------|
| A ¹ | 3 1/16" | 100mm | 4 1/16" 119mm |
| B ¹ | 3 7/16" | 87mm | 4 1/16" 119mm |
| C ¹ | 5/8" | 16mm | 1 1/16" 33mm |
| D ¹ | 1 1/8" | 48mm | 2 1/4" 57mm |

* For Fascia, Subtract 1 1/16" (27mm) from dimensions A and D.

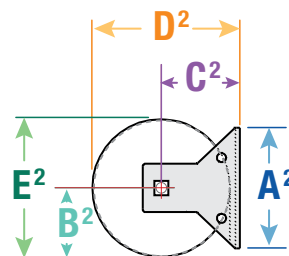

| BRACKETS | | | |
|----------------|--------|-------|--------------|
| SMALL | | LARGE | |
| A ² | 2 1/2" | 64mm | 3 1/4" 83mm |
| B ² | 1 3/8" | 35mm | 2" 51mm |
| C ² | 1 1/8" | 41mm | 2 1/4" 57mm |
| D ² | 3" | 76mm | 4 1/4" 108mm |
| E ² | 3 3/8" | 78mm | 4" 102mm |

FlexShade Motor

OPTIONS:

- 120V Standard AC Motor
- 120V RTS AC Motor
- 120V 485 Intelligent AC Motor

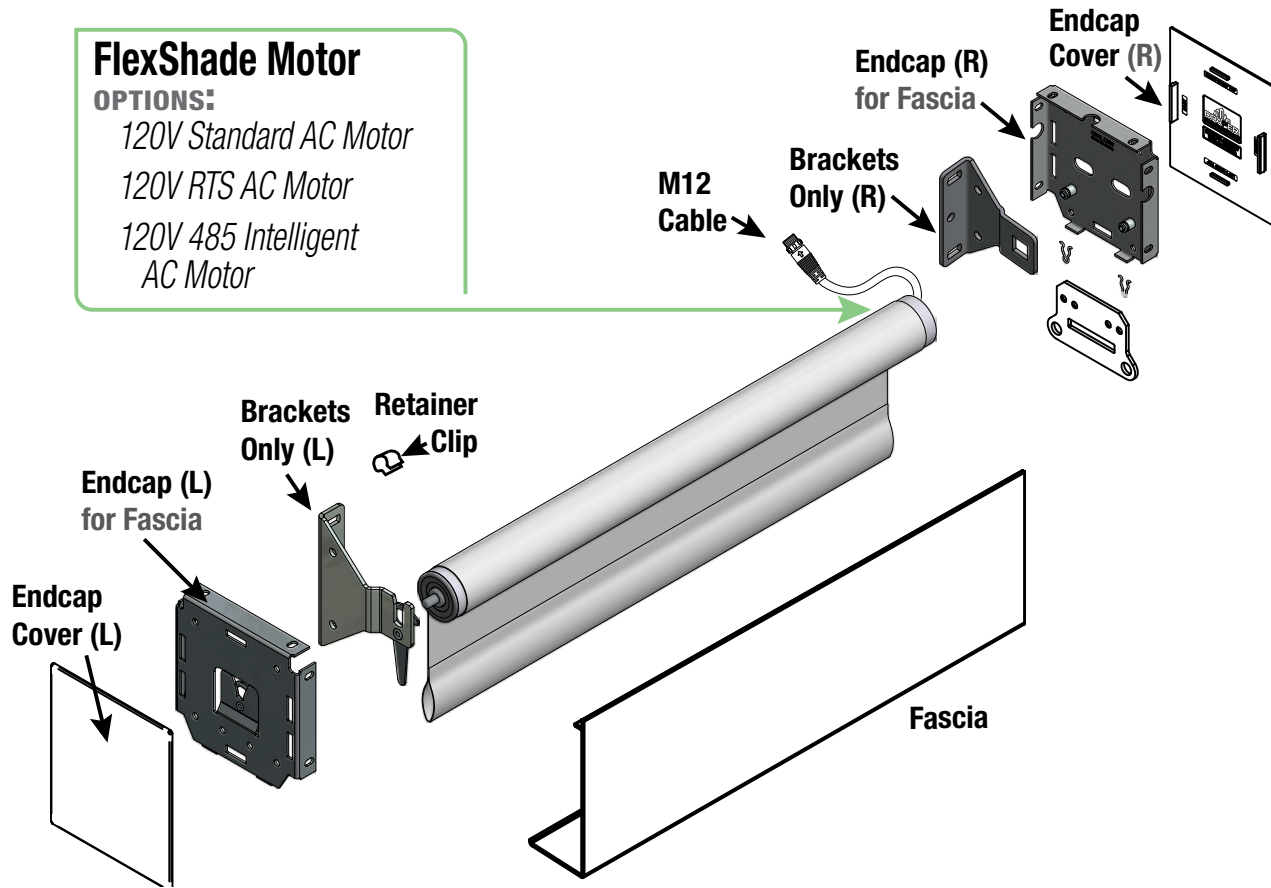

Wiring Diagrams *Sonesse® is a registered trademark of Somfy® Systems, Inc.*

Controls & System Overview

Sonesse® 120VAC Motors

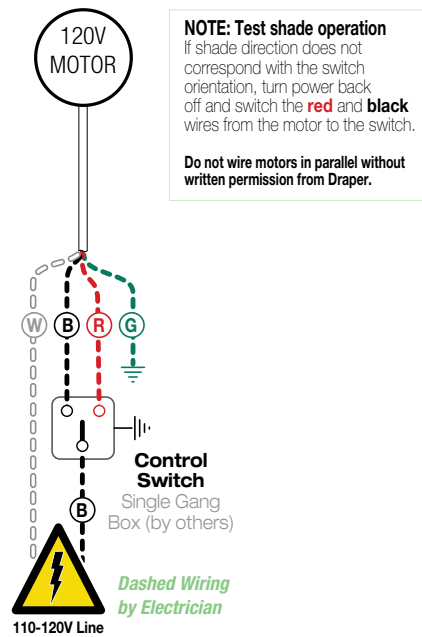

Controls & System Overview

Sonesse® RTS 120VAC Motors

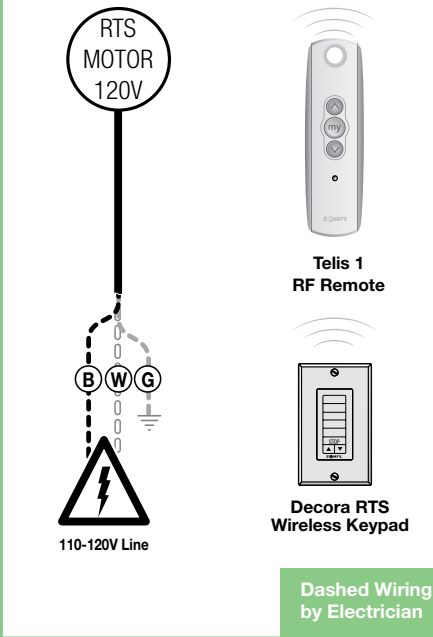

Controls & System Overview

Sonesse® RS485 120VAC Motors

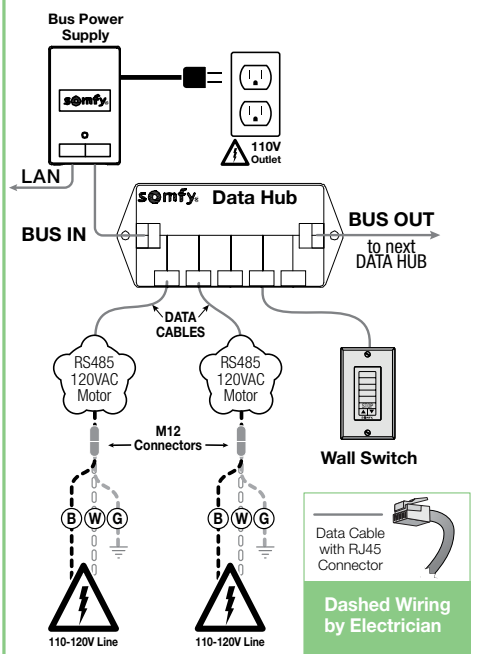

Data Cable Pin-Out - RJ45 Connector

