

LVC-IV Low Voltage Control Wiring Diagrams for All Draper Products

Technical Specifications:

Power Supply: 110V-120V / 60Hz
 Temperature: -40° C – 85° C
 Frequency: 433 MHz
 Power: <300W
 Transmit Power: <10mW
 Sensitivity: -110dBm
 Fuse: 3.15 Amp

Notes:

- Don't let the RF receiver touch metal objects; this could affect the maximum distance the transmitter can be from the RF receiver.
- Disconnect the power supply before installing the RF receiver.
- Avoid electrostatic interference: Static electricity will damage the electronic components.
- Make sure there is more than 5 feet between the RF receiver and ground.
- Make sure there is more than 1 foot between the RF receiver and ceiling.
- Make sure there is more than 1 foot between the RF receiver and transmitter.
- If using more than one receiver, make sure they are separated by more than 8 inches.

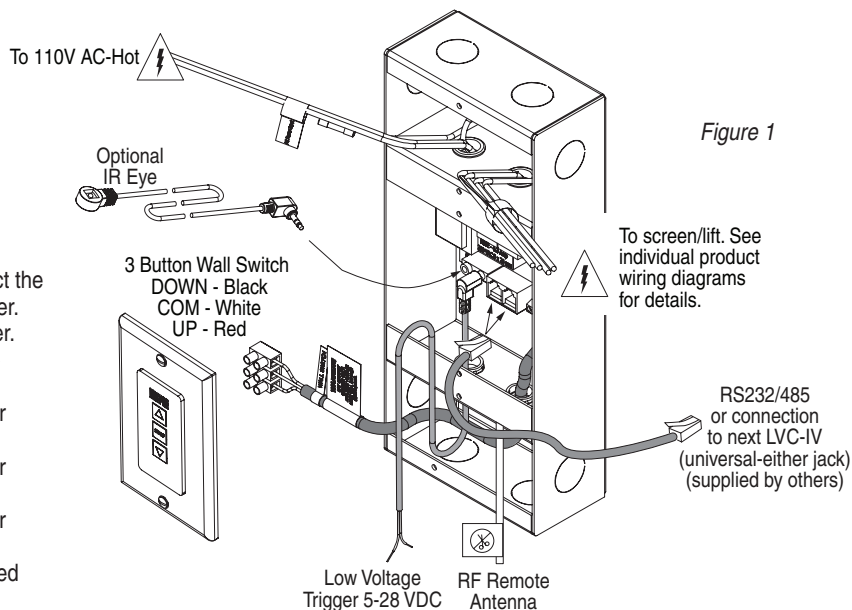

Figure 1

Radio Frequency (RF) Remote Control

The LVC-IV comes with built-in Radio Frequency Remote control capability (optional handheld transmitter NOT included).

To "Learn" a remote

- ① Press receiver button on LVC-IV (see Fig. 2A).
- ② Signal light will flash slowly.
- ③ Press transmitter's Up button within 10 seconds (see Fig. 2B).
- ④ Signal light flashes three times quickly.

To "Un-Learn" a remote

- ① Press receiver button on LVC-IV (see Fig. 2A).
- ② Signal light will flash slowly.
- ③ Press transmitter's Down button within 10 seconds (see Fig. 2C).
- ④ Signal light flashes three times quickly.

To "Un-Learn" all remotes

- ① Press receiver button on LVC-IV until signal light flashes quickly, then release.
- ② Press receiver button once while signal light is flashing.
- ③ Signal light will stop flashing.

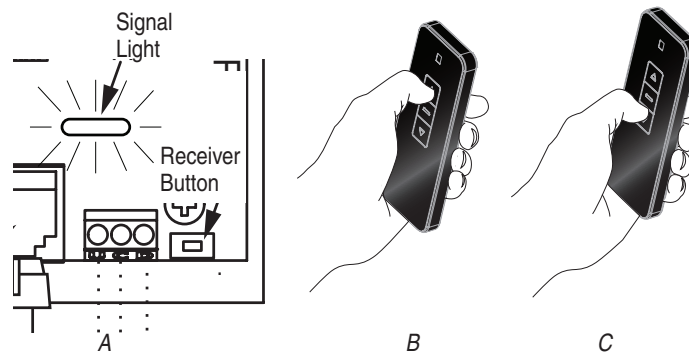

Figure 2

Please Note: Operating range is 250ft (open distance). RF Signal will degrade significantly with each wall it is required to penetrate. If you are experiencing issues with RF signal strength, the RF antenna can be threaded out one of the knockouts for better reception.

InfraRed (IR) Remote Control

- ① Plug Optional IR Eye into mini plug input provided on LVC-IV (see Figs. 1 and 3).
- ② IR Remote Control transmitter does not need to be "learned" by the LVC-IV. Simply point and operate.
- ③ **Maximum IR Eye cable length is 42".**

Please Note: IR Transmitter Range is 26ft.



Figure 3

DC Low Voltage Trigger

The LVC-IV comes with built-in connection for sending a DC trigger (5-28 VDC) from the projector to the projection screen.

- ① Connect remote trigger voltage from projector to the low voltage trigger cable.
- ② Plug the mini-jack plug of the low voltage trigger cable to the LVC-IV (Figure 1 & 4).
- ③ When projector is 'ON' the low voltage output of the projector will cause LVC-IV to deploy projection screen.
 When projector 'OFF' the low voltage is removed from LVC-IV and projection screen will retract into case.

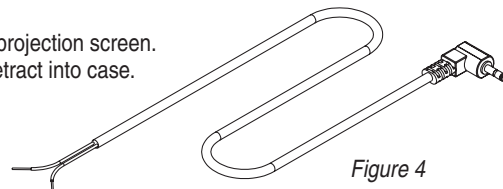

Figure 4



411 S. Pearl St., Spiceland, IN 47385 USA ■ 765-987-7999
 www.draperinc.com ■ fax 765-987-7142

Wiring Diagrams	
Projection Screens	Page 2
RS-232/485	Page 3

External LVC-IV—Single or Multiple Projection Screen Wiring Diagram

External LVC-IV—Single or Multiple Wiring Diagram for Ambassador and Rolleramic

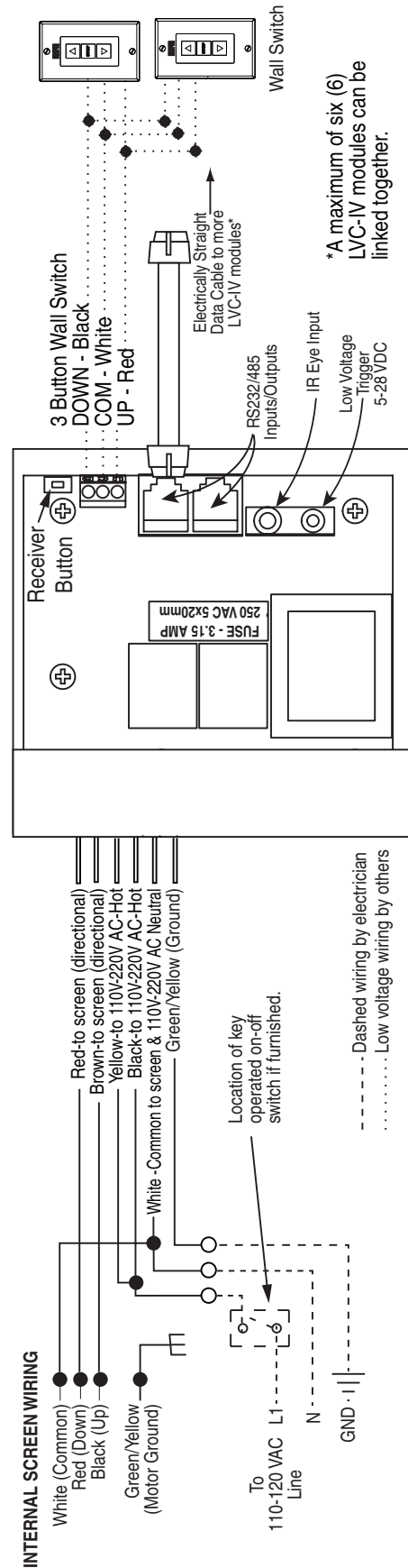
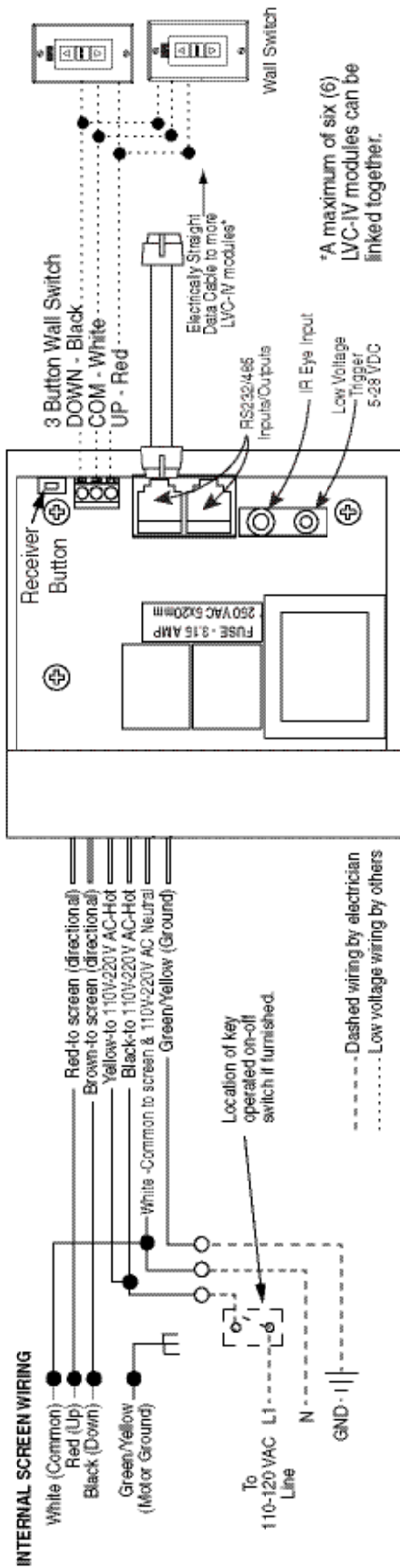

RS232 / RS485 Information

RS232 / RS485 CommPort Parameters:

- ① Frequency (BAUD Rate): 2400
- ② Data long code : 8
- ③ Parity Check : N
- ④ Start bit : 1
- ⑤ Stop bit : 1
- ⑥ Flow Control : NONE

Please Note:

Connections using modular cable must be made using **electrically straight** 6-conductor modular cable (RJ25). This means colors do not cross over: blue leads to blue, green to green, etc. (see diagram at right)

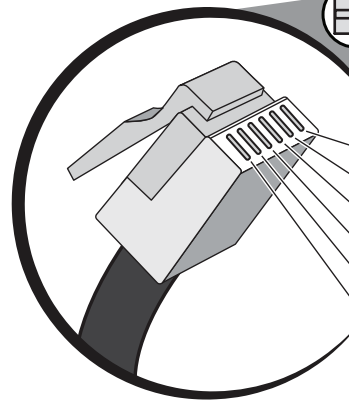
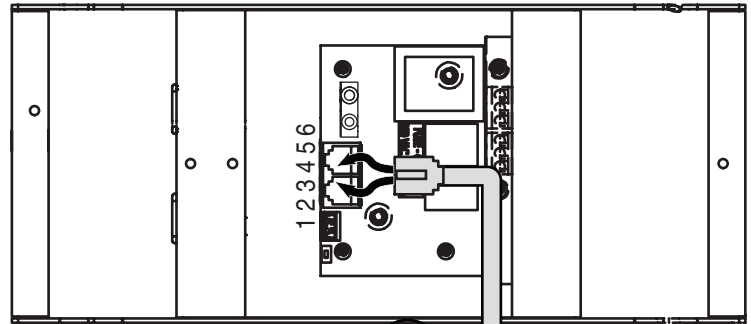

- PIN 1 - 5VDC Output
- PIN 2 - Down
- PIN 3 - Up
- PIN 4 - Ground
- PIN 5 - RS485-A or RS232-GND
- PIN 6 - RS485-B or RS232-Tx

COMMAND	COMMAND STRINGS	REMARK
UP	9A 01 01 00 0A DD D7	ID No. : 1 / Channel : 01
STOP	9A 01 01 00 0A CC C6	ID No. : 1 / Channel : 01
DOWN	9A 01 01 00 0A EE E4	ID No. : 1 / Channel : 01

For more detailed programming instructions or group control go to:
<http://www.draperinc.com/DraperPro>
 (registration required)

LVC-IV—Dimensions

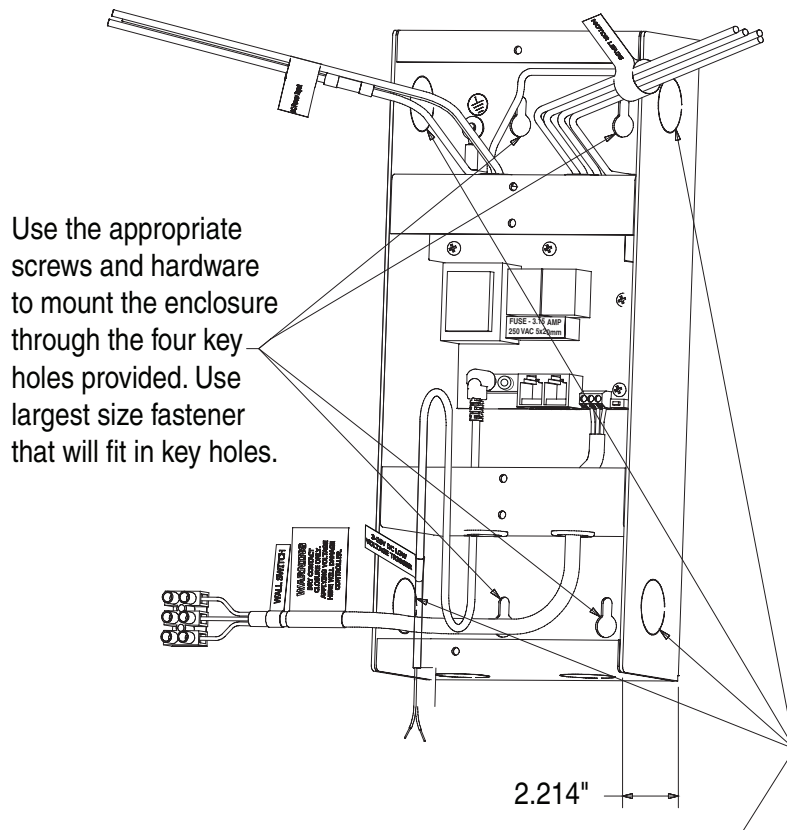

Use the appropriate screws and hardware to mount the enclosure through the four key holes provided. Use largest size fastener that will fit in key holes.

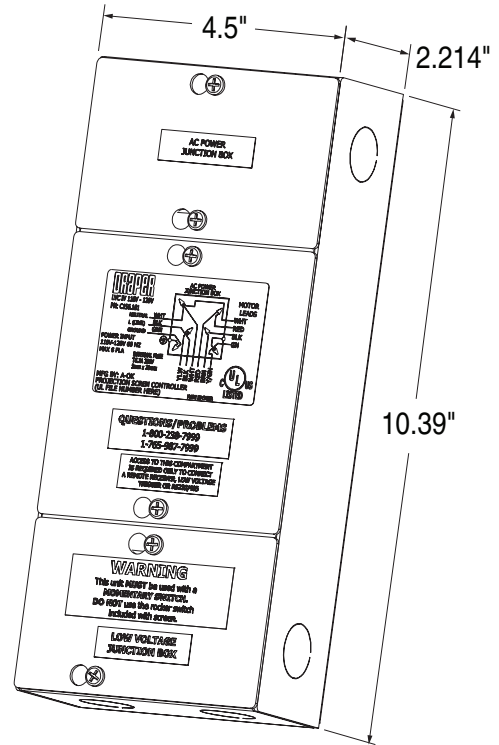

For AC supply wires attach appropriate 1/2" Trade Size connector to route wiring through knockouts. For low voltage wires attach with appropriate connector to route wiring through knockouts. Knockouts are provided on all four sides of the enclosure.