

# Motorized FlexStyle™

Motor operated window shades with low-profile decorative brackets

## INSTRUCTIONS INSTALLATION & OPERATION

### Overview - Components

#### FLEXSTYLE MO FLEXSTYLE MOZ

These instructions apply to all Draper® Motorized FlexStyle™ window shades using the following motors:

##### 120VAC MOTORS

Intelliflex I/O D45AE- $\frac{5}{8}$ AC120V 6Nm
Somfy Round Head 50mm or 500 Series
Sonesse Ultra RH RTS $\frac{5}{24}$ (Uq) #1002564
506s2 Sonesse RH $\frac{5}{24}$ (Qt50) #1001812 0.58
Sonesse Ultra RH $\frac{5}{24}$ (Uq) #1002560

##### 24VDC MOTORS

Square Head 504A8 Sonesse Ultra DC 485 $\frac{4}{32}$ 24VDC
Square Head 504A8 Sonesse Ultra DC RTS $\frac{4}{32}$ 24VDC 0.66

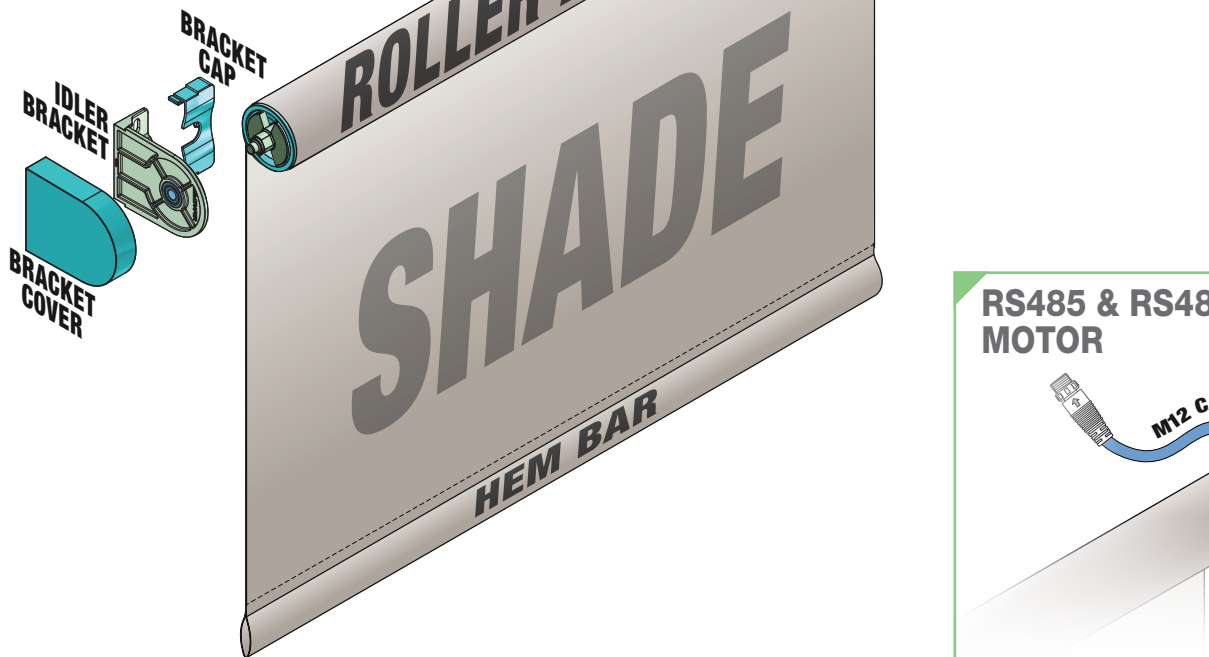

#### RS485 & RS485 ULTRA MOTOR

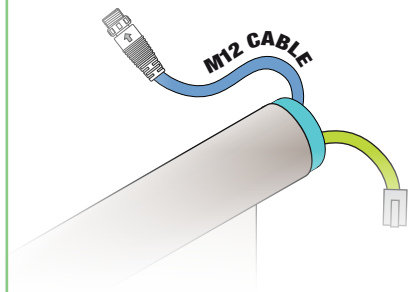

#### TOOLS REQUIRED



PENCIL

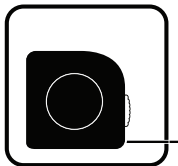

TAPE MEASURE

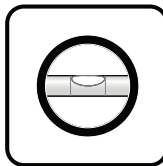

LEVEL



POWER DRILL

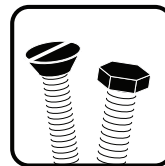

HARDWARE (by others)

#### ⚠ CAUTION ⚠

**Read and understand all warnings (Page 2 of this document) before beginning installation.**

#### Contents

Overview - Components.....	1	Section 3 - Removing Bracket Covers .....	5
PLEASE READ - Important Safety & Installation Information .....	2	Section 4 - Electrical Connections .....	5
PLEASE READ - Field Adjustments, Cleaning and Maintenance .....	2	Section 5 - RF Remote Programming Instructions .....	6
Section 1 - Installing Mounting Brackets.....	3	Section 6 - Dimensions .....	7
Section 2 - Mounting Shade.....	4	Section 7 - Dimensions .....	8

If you have any difficulties installing or servicing your Motorized FlexStyle™, call your dealer or Draper, Inc.

## PLEASE READ - Important Installation Information

### ⚠ Caution:

1. Inspect all boxes to make sure you have received the proper shades and parts. Controls may be shipped separately, or in same carton as shades.
2. Open cartons lengthwise, taking care not to cut into cardboard shipping container.
3. Before mounting shades, verify measurements on label provided with shade, and ensure unit is installed at correct width.
4. All hardware must be installed level. Shades must be level and square.
5. **Read the following installation guidelines thoroughly and follow them carefully. Failure to do so may cause product to fall or otherwise fail, and invalidates warranty.**
6. **Installer is responsible for selecting mounting hardware appropriate for site conditions.**

## PLEASE READ - Safety Information

### Important Safety Information



### Important Safety Information

**Improper installation and use of the Motorized FlexStyle® can result in serious injury or death. Primarily, injuries can occur if the unit falls due to imprecise installation, mishandling of the unit during installation, or installation on an insufficient wall or ceiling structure. Please use extreme care.**

1. Please read the following installation guidelines thoroughly and follow them carefully. Failure to do so may cause product to fall or otherwise fail, and could result in serious injury.
2. Installation and calibration of the unit should only be performed by an authorized, qualified, and experienced professional. In particular, electrical work and wiring [indicated in diagram by dashed lines] must be completed only by a qualified professional electrician who has read this manual completely and is familiar with the construction and operation of this equipment and the hazards involved.
3. Do not affix the unit to wall or ceilings that have inadequate strength to permanently hold the unit during use. It is the owner's and installer's responsibility to confirm the wall or ceiling to which the unit attaches is sufficient to permanently hold the weight and stress loads of the unit at all times. Draper®, Inc., is not responsible for improper installation, application, testing, or workmanship related to the product at place of installation.
4. It is the installer's responsibility to make sure appropriate fasteners are used for mounting.
5. All hardware must be installed level. Unit must be level and square.
6. Never leave the area while operating the unit during installation, maintenance, or normal operation, unless it is secure and safe.
7. Before testing or operation, carefully inspect the entire area and path of the shade and areas underneath the shade to be sure no persons or objects are in the area.
8. Turn off power and any nearby equipment or cables carrying electricity before connecting switches, wires, controls, or electrical components.
9. Make sure the limit switches are pointed down or accessible when placing the motor in brackets.
10. All motors should be tested and limits set using test cord before shades are wired.
11. Do not wire motors in parallel without written permission from Draper, Inc.
12. During testing or operation, carefully watch the surrounding area for any potential safety concerns including nearby persons or objects.
13. Do not use an extension cord. If the power supply cord is too short, have a qualified electrician install an outlet near the drapery operator.
14. After installation, the entire system, including all sensors, should be carefully tested to ensure safe and normal operation. Extreme care should be taken during testing to remain clear of moving parts to avoid possible injury.
15. Operation of unit should be performed only by authorized and qualified personnel, who have been trained in the safe and effective operation of the unit and understand its safety features.
16. The safety features of the unit, including sensors, should never be disabled, bypassed, or overridden. The system should not be operated until all safety features, including the sensors, are properly and completely installed, calibrated, and tested.
17. Unit may need to comply with local, state, or district rules and regulations, in particular when installed in schools. All applicable rules and regulations should be reviewed before installation and use.
18. Failure to precisely follow installation guidelines invalidates all warranties.
19. Custom products/installations may not be reflected in this manual. Call Draper, Inc., if you have questions about the installation of custom products or any questions about your installation.

### Before Beginning Installation

1. Look for any job site conditions that could interfere with installation or operation of the system.
2. Read carefully and be sure to understand all installation instructions and all related operations manuals. These instructions are intended to serve as a guide for the installer and owner. They should be followed closely and combined with the expertise of experienced qualified installers. Draper, Inc., is not responsible for improper installation, application, testing, or workmanship related to the product at place of installation. Please retain all instructions for future use.
3. Open cartons lengthwise.
4. Locate and lay out all pieces.
5. Inspect all boxes to make sure you have received the proper shade and parts. Controls may be shipped separately, or in same carton as shade.
6. If you have any difficulties with installing, servicing, or operating your shade, call your dealer or Draper, Inc., 765-987-7999.

## PLEASE READ - Field Adjustments

Each Draper Solar Control Shade is tested to ensure proper operation. Even with this testing, some field adjustments may be needed for telescoping.

If the shade is telescoping, place a piece of shimming fabric into the fabric roll when the shade is deployed on the side that the fabric will be drawn toward. For example: if the fabric is tracking to the left, place the shimming fabric on the right side.

## PLEASE READ - Cleaning and Maintenance

Window covering products manufactured by Draper, when properly installed, should require no operational maintenance or lubrication.

Most standard Draper fabrics may be cleaned at the window by vacuuming with a soft brush attachment. They also may be cleaned by using a sponge or soft cloth and mild solution of warm soapy water. A mild dishwashing liquid is recommended. A clean dry cloth is recommended for the metal finish.

**Please Note:** Exceptions are GreenScreen Evolve®, GreenScreen Revive®, and Phifer® SW7000 fabrics, which must be cleaned with a dry art sponge.  
*(GreenScreen Revive® and GreenScreen Evolve® are registered trademarks of Mermet® USA. SheerWeave® is a registered trademark of Phifer® Incorporated.)*

## Section 1 - Installing Mounting Brackets

**IMPORTANT:** Mounting Brackets must be installed parallel, plumb, and square, with a tolerance of  $\pm 1/8"$  (3mm). Verify unit measurements and ensure unit will fit in the desired location.

**Please Note:** Installer is responsible for selecting mounting hardware appropriate for site conditions.

1. Mark wall or ceiling for placement of mounting brackets. (Idler Bracket shown.)

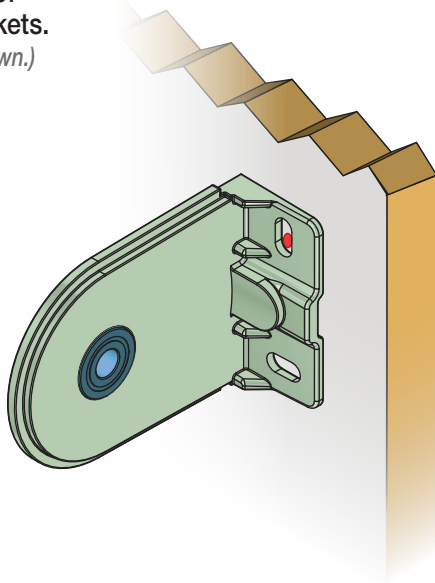

2. Drill small starter hole in mounting surface (if necessary).

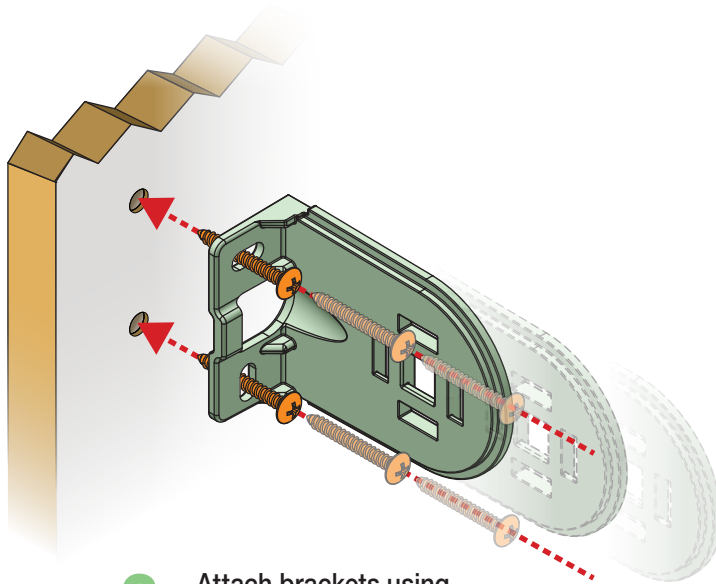
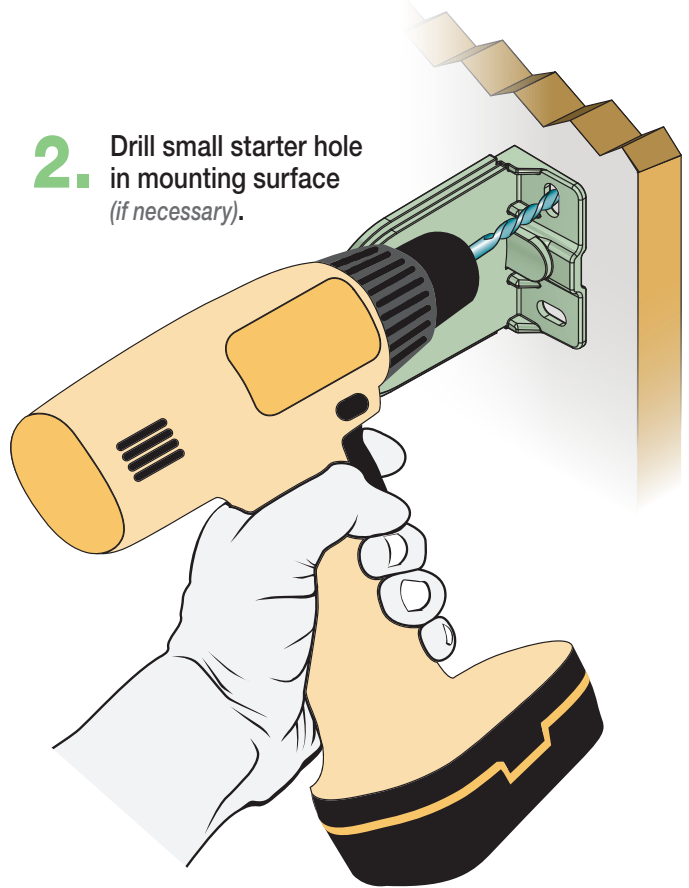

3. Attach brackets using appropriate fasteners (by others) for mounting surface. (Motor Bracket shown.)

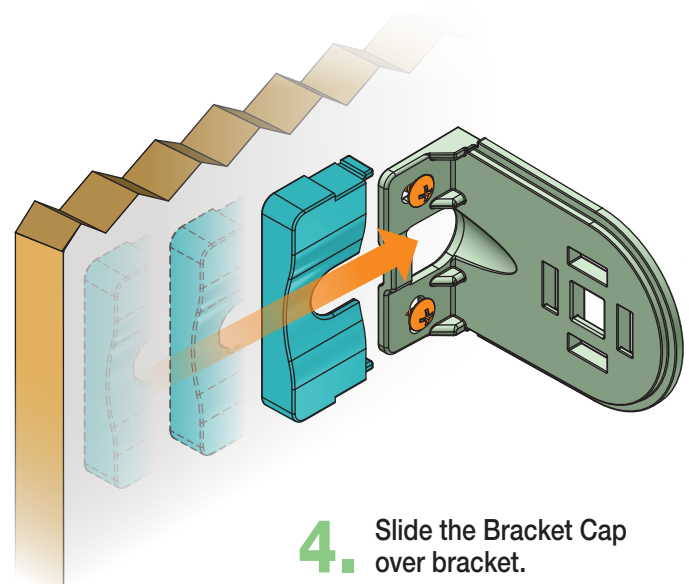

4. Slide the Bracket Cap over bracket. (Motor Bracket shown.)

## Section 2 - Mounting Shade

**Please Note:** ALWAYS START AT THE IDLER END OF SHADE.

**Please Note:** This shade must be mounted to wall or ceiling. No jamb mounting option available.

1. Lift idler end of the fabric/roller assembly into place and align between the brackets.

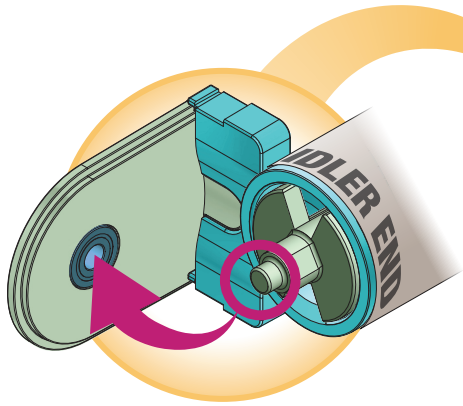

2. Depress spring-loaded end of shade and insert it into hole in Idler Bracket.

3. Feed cable through hole in bracket.

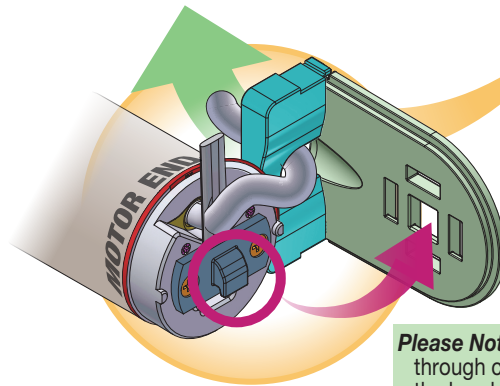

4. Hook Motor Plate into hole on the Motor Bracket.

**Please Note:** If cable does not fit through cutout, drill a hole near the bracket in a hidden location.

5. Slide Bracket Covers over brackets.

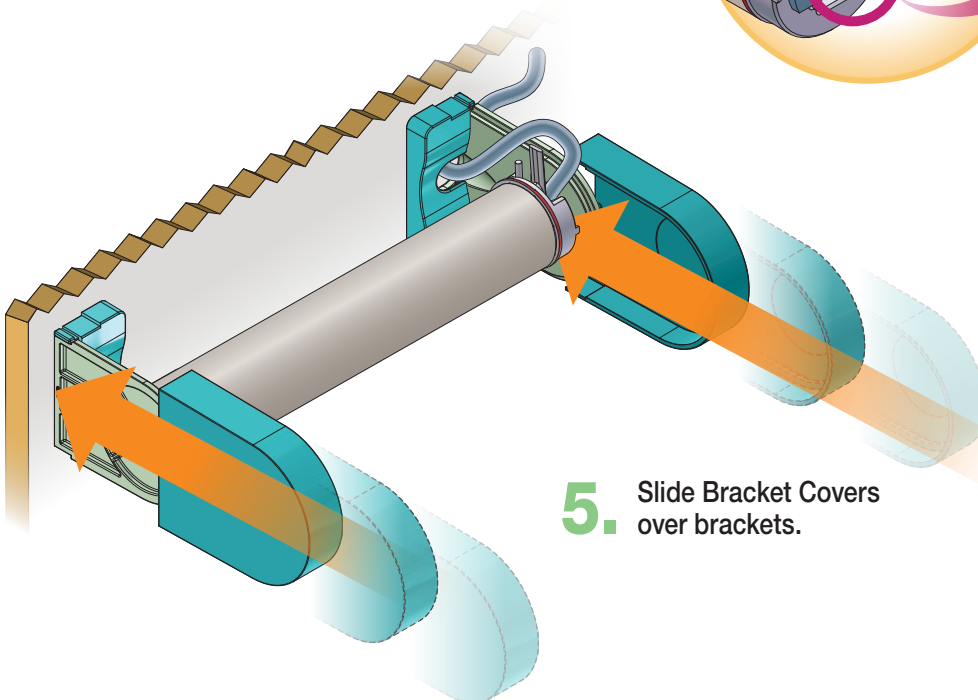

6. Ensure that Bracket Cover SNAPS into place. (Idler Bracket shown.)

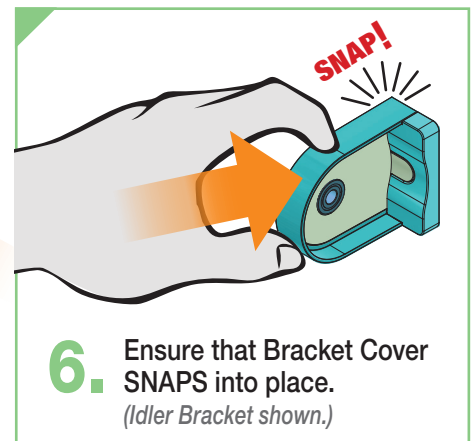

## Section 3 - Removing Bracket Covers (Must be ordered separately.)

**Please Note:** The Cover Removal Tool (Part Number C202.053) is available if bracket covers need to be detached for any reason.

1. Grasp the flat end of the bracket.  
(Motor Bracket shown.)

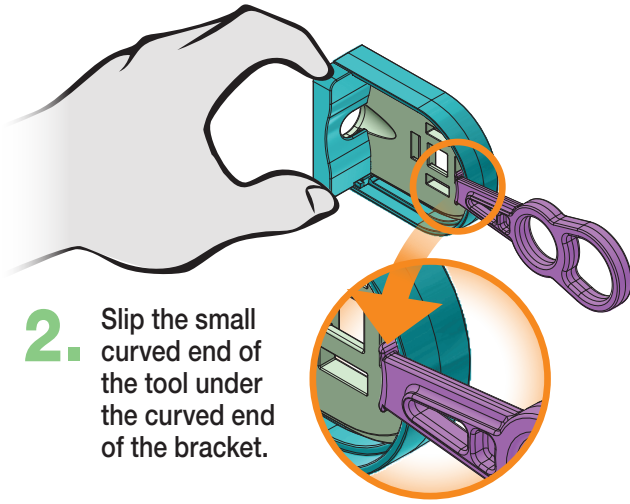

2. Slip the small curved end of the tool under the curved end of the bracket.

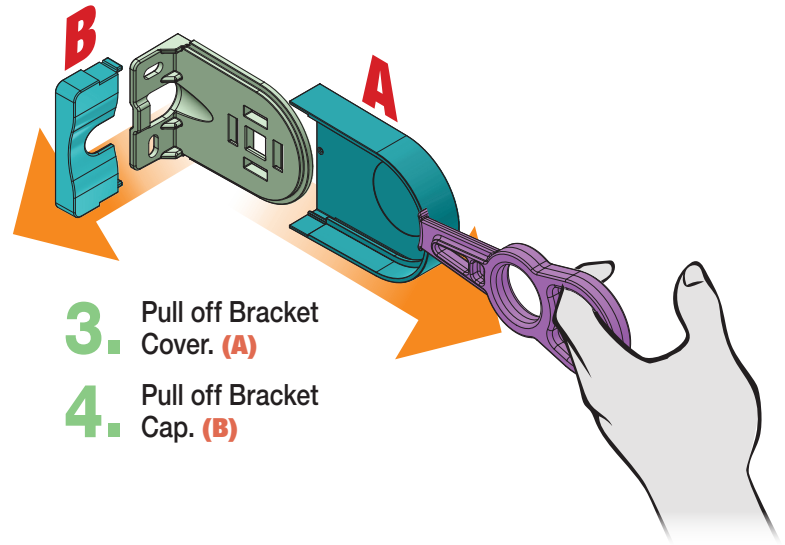

3. Pull off Bracket Cover. (A)
4. Pull off Bracket Cap. (B)

## Section 4 - Electrical Connections

Shade operates on 110-120V, 60 Hz. current. Shade is shipped with internal wiring complete and control switch(es) fully boxed, and standardly supplied with a 6' (1.82m) cable lead. Wire to connect shade to switch(es), and switch(es) to power supply, should be furnished by installer. Connections should be made in accordance with attached wiring diagram, and wiring should comply with national and local electrical codes.

**⚠ Caution:** DO NOT wire motors in parallel without written permission from Draper.

**⚠ Caution:** All operating switches should be "off" before power is connected.

**Please Note:** For low-voltage wiring requirements, Draper recommends consulting with a professional low-voltage electrical contractor. It is very important that shielded and stranded CAT 5 cable be used to prevent any electrical interference.

## Section 5 - RF Remote Programming Instructions

**Please Note:** The motor ships with no programming. Follow these instructions to program unit to the desired transmitter.

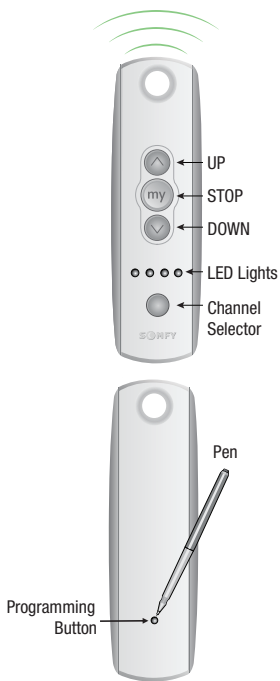

1. Select a transmitter channel to assign motor. Hold UP and DOWN buttons until motor jogs, then release.
2. Check motor direction. To reverse motor direction, hold MY/STOP button for 5 seconds until motor jogs. Check direction again.
3. Move motor to upper limit position. Hold MY/STOP and DOWN buttons until motor moves down, then release. Use UP and DOWN buttons to move shade to correct lower limit and press MY/STOP.
4. While motor is at lower limit, hold UP and MY/STOP buttons until motor moves up, then release. The shade should move to upper limit and stop.
5. Next, hold MY/STOP button until motor jogs.
6. Put motor into USER MODE by briefly pressing small programming button on the back of the transmitter. Motor will jog.
7. If programming additional shades on the same channel, put this motor to sleep until all motors on the same channel are programmed. To put to sleep, hold button on motor head for one jog, release. Then hold UP/STOP/DOWN all at the same time and wait for shade to jog. Motor is now asleep.
8. To wake motor up after putting to sleep, hold button on motor head for 1 second. Shade will jog to indicate it is now awake.

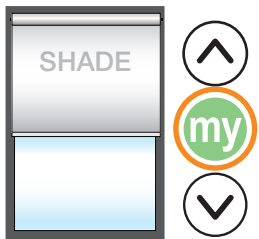
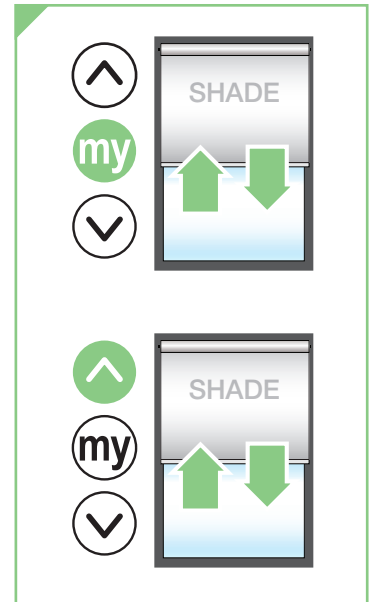

### Setting an Intermediate Stop - Shade MUST BE in USER mode.

1. Move shade to desired mid-point location and hold MY/STOP button until motor jogs.
2. To test, press the MY/STOP button when motor is standing still. The shade will move to that intermediate location.
3. To delete an intermediate stop, go to the intermediate stop and hold the MY/STOP button until motor jogs.

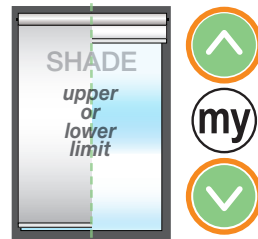

### Adjust Limits in User Mode

1. Move motor to limit (upper or lower) to be changed. Shade must move to previously set limit and will stop automatically.
2. Hold UP and DOWN buttons until motor jogs.
3. Move motor to its new limit location and hold MY/STOP button until motor jogs.

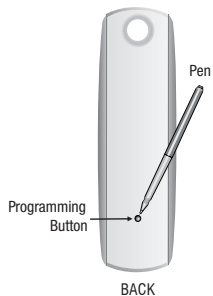

### Add a Channel - Shade MUST BE in USER mode.

1. Select channel currently operating motor, then hold programming button until motor jogs.
2. Select new channel to add to motor, then hold programming button until motor jogs.
3. The motor should now work on both the old and new channels.

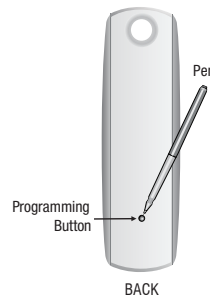

### Reset Motor

1. Hold button on remote and wait for 3 jogs. Motor is now reset.

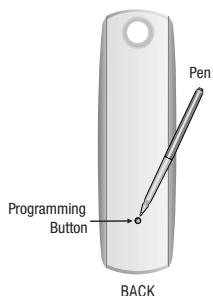

### Delete a Channel - Shade MUST BE in USER mode.

1. Select channel operating motor that you want to keep, then hold programming button until motor jogs.
2. Select channel to remove, then hold programming button until motor jogs. Motor should now only work on channel kept from Step 1.

## Section 6 - Dimensions

C002.1822 (Idler End, Extended)

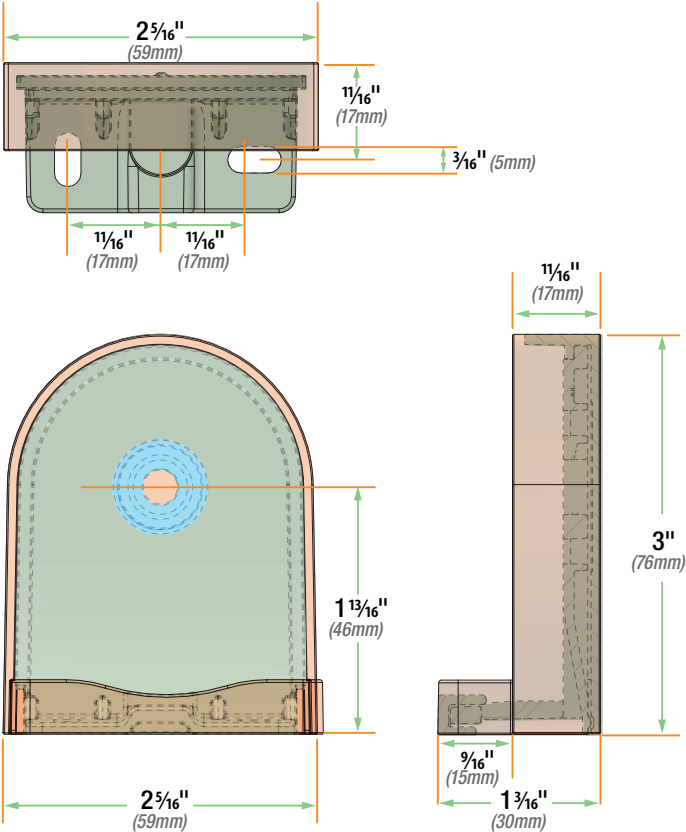

C002.1820 (Motor End, Extended)

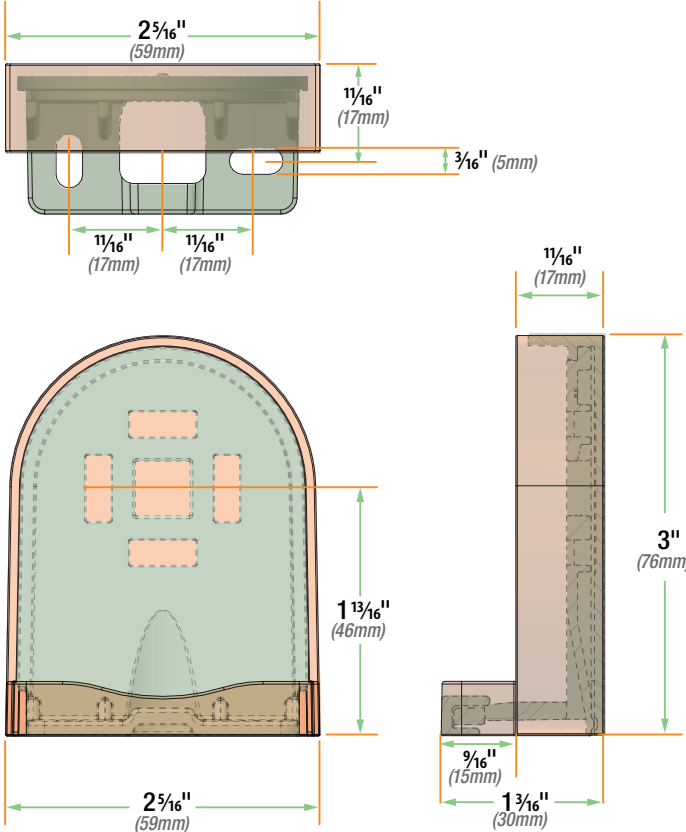

Section 7 - **Dimensions**

